



# Product list

V-TRAK

Component list | **Click below to navigate**

Directions for use >? If you are using this on your computer please click on the numbers below to take direct to the page

1	Contents
2	Backrests   Axxis One piece , Segmented & Profile
3	Spare Covers & Clip on Foams
3	Backrests   Comfort, Evo+, Spare covers & Foams
4	Mounting hardware   V-Trak
5	Mounting hardware   Mounting blocks
6	Mounting hardware   Product specific Mounting blocks
7	Accessories   X-Tend Headrests
8	Accessories   Headrest Accessories & V-Trak headrests
9	Accessories   Laterals
10	Accessories   Harness carriers & Secondary arms
11	Accessories   V-Trak Accessories
12	Specialist seating   Hardware & Tracks
13	Specialist seating   Parts, Recycling kits & Fabric

## IMPORTANT INFORMATION

For consignment stock or demos please contact Veena Patel our customer services manager.  
Phone number +44 (0)1443 236530

Please contact us for our recycling scheme

## TECHNICAL INFORMATION

This price list has all components to complete a V-Trak system, We have a simpler Box range order form to make ordering a complete system easier and cheaper.

For information on our UK services > [www.intsm.com](http://www.intsm.com)  
For product information please visit > [www.v-trak.com](http://www.v-trak.com)  
For product demos please visit > [www.youtube.com/specialistseating](http://www.youtube.com/specialistseating)

## CONTACT DETAILS

Any problems with technical issues, prices or ordering please contact -

### Performance Health Products

Unit 1, Westside Cambrian Industrial Estate, Coed Cae Lane  
Pontyclun, CF72 9EX, UK

Tel: +44 (0)1443 236530

[info@v-trak.com](mailto:info@v-trak.com) | [www.v-trak.com](http://www.v-trak.com)



# Product list

V-TRAK

Backrests | Axxis One piece , Segmented & Profile

## Axxis backrests

**AXXIS ONE-PIECE BACKRESTS - With adjustable lateral support - All backrests can be used with V-Trak Original hardware or V-Trak Lite hardware**

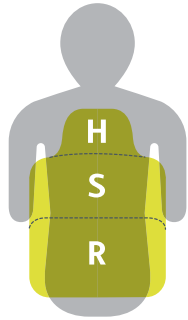

PRODUCT CODE	DESCRIPTION	HEIGHT cm	WIDTH cm
AXH-XL	High - Extra Large - Backrest	61	50 > 41
AXH-L	High - Large - Backrest	61	43 > 35
AXH-M	High - Medium - Backrest	61	38 > 30
AXS-XL	Standard Height - Extra Large - Backrest	40	50 > 41
AXS-L	Standard Height - Large -Backrest	40	43 > 35
AXS-M	Standard Height - Medium-Backrest	40	38 > 30
AXR-XL	Reduced Height - Extra Large - Backrest	30	50 > 41
AXR-L	Reduced Height - Large- Backrest	30	43 > 35
AXR-M	Reduced Height - Medium Backrest	30	38 > 30
AXR-S	Reduced Height - Small Backrest	30	33 > 26

**NEW AXXIS PROFILE BACKRESTS - Shaped backrest with adjustable lateral support (low backrests can be inverted to reverse shape)**

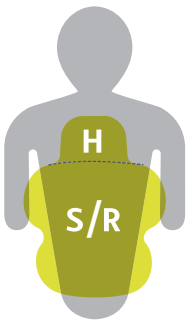

PRODUCT CODE	DESCRIPTION	HEIGHT cm	WIDTH cm	W-BOTTOM
AXPH-XL	High - Extra Large - Profile Backrest	61	50 > 41	43 > 35
AXPH-L	High - Large - Profile Backrest	61	43 > 35	38 > 30
AXPH-M	High - Medium - Profile Backrest	56	38 > 30	33 > 26
AXPS-XL	Standard Height - Extra Large - Profile Backrest	40	50 > 41	43 > 35
AXPS-L	Standard Height - Large -Profile Backrest	40	43 > 35	38 > 30
AXPS-M	Standard Height - Medium-Profile Backrest	36	38 > 30	33 > 26
AXPR-XL	Reduced Height - Extra Large - Profile Backrest	30	50 > 41	43 > 35
AXPR-L	Reduced Height - Large- Profile Backrest	30	43 > 35	38 > 30
AXPR -M	Reduced Height - Medium - Profile Backrest	30	38 > 30	33 > 26

**AXXIS SEGMENTED BACKRESTS - Use singly, in multiples and with Backrest Extensions - Hardware and connecting hinge (SH SD) need to be ordered**



PRODUCT CODE	DESCRIPTION	HEIGHT cm	WIDTH cm
AXSB-XLF	Extra Large Full Height Segment	20	50 > 41
AXSB-XLR	Extra Large Reduced Height Segment	17	50 > 41
AXSB-LF	Large Full Height Segment	20	43 > 35
AXSB-LR	Large Reduced Height Segment	16	43 > 35
AXSB-MF	Medium Full Height Segment	20	38 > 30
AXSB-MR	Medium Reduced Height Segment	15	38 > 30
AXSB-SF	Small Full Height Segment	17	33 > 26
AXSB-SR	Small Reduced Height Segment	14	33 > 26
AXSB-XSR	Small Extra Reduced segment	12	33 > 26
AXSB-XXSR	Small Extra Extra Reduced segment	10	33 > 26



PRODUCT CODE	DESCRIPTION	HEIGHT cm	WIDTH cm
<b>AXXIS Backrest extensions - Can be used with Axxis segmented or as an addition to Standard/reduced height backrests</b>			
BK XTL	Axxis Backrest Extension Large	21	33
BK XTM	Axxis Backrest Extension Medium	17	27

## Hinge

**HARDWARE AND CONNECTING HINGE (SH SD)**



PRODUCT CODE	DESCRIPTION
SH SD	Joining and adjustment hinge for segments and extensions
Comes complete with 2 x bolts and one spare wing knob (as pictured) for quick release if needed.	



# Product list

V-TRAK

## Backrests | Comfort, Evo+, Spare covers & Foams

### Comfort backrests

**Comfort One-Piece Backrests excl. hardware - With internal adjustable lateral support - All backrests can be used with all V-Trak hardware**

PRODUCT CODE	DESCRIPTION	HEIGHT cm	WIDTH cm
COL 17	Comfort Long - Backrest	59	43
COL 15	Comfort Long - Backrest	59	38
COS 17	Comfort Short - Backrest	40	43
COS 15	Comfort Short - Backrest	40	38

### Evo+ backrests

**EVO+ BACKRESTS -Simple and comfortable Light weight backrest perfect for V-Trak lite hardware**

PRODUCT CODE	DESCRIPTION	HEIGHT cm	WIDTH cm
EVO + 15	EVO Plus Backrest 15" wide	40	46
EVO + 16	EVO Plus Backrest 16" wide	40	43
EVO + 17	EVO Plus Backrest 17" wide	38	40
EVO + 18	EVO Plus Backrest 18" wide	38	38

### Spare Covers & Clip on Foams

**SPARE BACKREST COVERS - Rember to include product specific code of backrest. If cover choice different from standard please include material**

BACKREST RANGE	CODE	DESCRIPTION
Axxis segmented	CV- _____	Spare cover for all Axxis segments and backrest extensions
Axxis one piece	CV- _____	Spare cover for all Axxis one piece backrests
Axxis Profile	CV- _____	Spare cover for all Axxis Profile backrests
Comfort	CV- _____	Spare cover for all Comfort backrests
Evo+	CV- _____	Spare cover for all Evo+ backrests

**SPARE FOAMS - Rember to include product specific code of backrest**

BACKREST RANGE	CODE	DESCRIPTION
Axxis segmented	CF- _____	Replacement Clip on foam for all segments and backrest extensions
Axxis one piece	CF- _____	Replacement Clip on foam for all Axxis one piece backrests
Axxis profile	CF- _____	Replacement Clip on foam for all Axxis Profile backrests
Comfort	CF- _____	Replacement Clip on foam for all Comfort backrests
Evo+	CF- _____	Replacement Clip on foam for all Evo+ backrests

**SPARE STRAPS - Please remember to include product specific code of backrest**

BACKREST	CODE	DESCRIPTION
Axxis & Comfort	ST- _____	Replacement internal elastic straps for all Axxis range & Comfort backs

**COVER CHOICE - For backrest cover material choice**

MATERIAL CODE	DESCRIPTION
WF	<b>Woven fabric</b> - MFC with water-resistant backing- (Axxis segmented and Axxis one piece as standard)
BB	<b>Breathable Black</b> - Spacer Fabric - (Axxis Profile range as standard)
DT	<b>Dual Tone</b> - Grey spacer fabric with contrasting MFC woven fabric - (Comfort range and Evo+ as standard)
WD	<b>Wipe down</b> - Water resistant polyurethane material

**For product refurbishment and re-issue all backrest ranges now come with replaceable covers and clip-on foams**

#### MATERIAL CODE INFORMATION

When ordering your backrest you have 4 covers to choose from. If you have a specific choice you can add the material code after and this will highlight your choice of material . If this is not done the backrest will be supplied in its standard cover material as listed above.

PRODUCT COVER CHOICE example > AXSBMF-(BB)- Axxis segment in Black breathable spacer fabric cover

SPARE COVER code example > (CV)-AXSBMF - Spare cover for an Axxis segment (if needed in a different material just add the code on the end)

SPARE FOAM code example > (CF)-AXSBMF - Spare Clip on foam for an Axxis segment



# Product list

V-TRAK

Mounting hardware | V-Trak

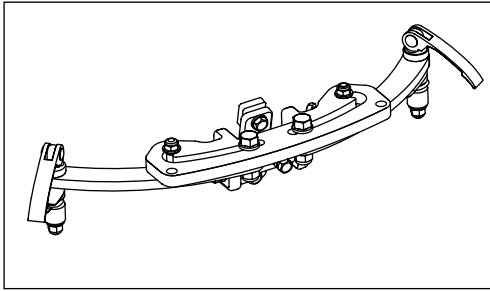

V-Trak Original- CMA- Including arms

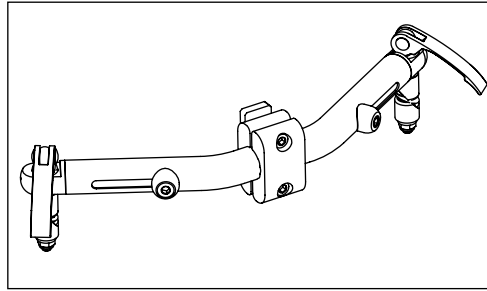

V-Trak Lite- VLA (Cranked)

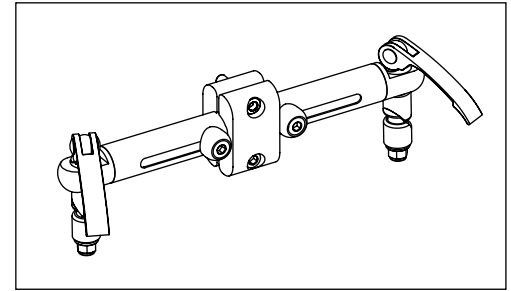

V-Trak Lite- VLP (Straight)

## V-Trak Original

V-Trak Original -Central Mounting Assemblies complete with Universal Central Mount (CMU)

PRODUCT CODE	DESCRIPTION	WIDTH RANGE between canes	Recommended Wheelchair width inch
CMA100	Assembly with 100mm arms	24cm - 41cm	11" 12" 13" 14"
CMA125	Assembly with 125mm arms	29cm - 46cm	15"
CMA 150	Assembly with 150mm arms	33cm - 49cm	16" 17"
CMA175	Assembly with 175mm arms	37cm - 52cm	18"
CMA200	Assembly with 200mm arms	40cm - 57cm	19" 20"
CMA225	Assembly with 225mm arms	43cm - 61cm	21"
CMA250	Assembly with 250mm arms	49cm- 67cm	22" 23" 24"

## V-Trak Lite

NEW V-Trak Lite mounting and adjustment hardware

PRODUCT CODE	DESCRIPTION	WIDTH RANGE between canes	Recommended Wheelchair width inches
VLPS	V-trak Lite Paediatric Small (Straight)	23cm - 37cm	9" 10" 11"12"
VLPM	V-trak Lite Paediatric Medium (Straight)	28cm - 42cm	13" 14"
VLAS	V-trak Lite Adult Small (Cranked)	30cm - 44cm	15" 16"
VLAM	V-trak Lite Adult Medium (Cranked)	36cm - 50cm	17" 18" 19"
VL15	V-trak Lite Inch specific (Cranked)		15"
VL16	V-trak Lite Inch specific (Cranked)		16"
VL17	V-trak Lite Inch specific (Cranked)		17"
VL18	V-trak Lite Inch specific (Cranked)		18"

## Central mounts only

Central Mounts only Use to join Arms of equal or different sizes and/or handing (left and right)

PRODUCT CODE	DESCRIPTION
CMU	Improved Universal Central Mount - Aluminium (recommended) with built in rotation lock
CM STD 2	Steel Central Mount (specialist application only, use with CMP LP below)
BM ALP	Locking plate for Steel Central Mount
CM STD	Steel Central mount, single hole fixing (for short segment tracks)

## Arms in pairs

Combine different sizes to achieve exceptional or extreme positioning/orientation

PRODUCT CODE	DESCRIPTION
AM100	V-Trak Arm, 100mm (pair)
AM125	V-Trak Arm, 125mm (pair)
AM150	V-Trak Arm, 150mm (pair)
AM175	V-Trak Arm, 175mm (pair)
AM200	V-Trak Arm, 200mm (pair)
AM225	V-Trak Arm, 225mm (pair)
AM250	V-Trak Arm, 250mm (pair)



# Product list

V-TRAK

## Mounting hardware | Mounting blocks

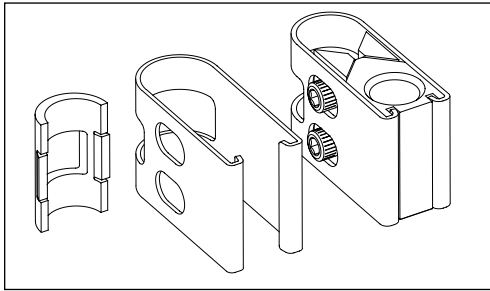

MBR-UE - 19/22/25 mm

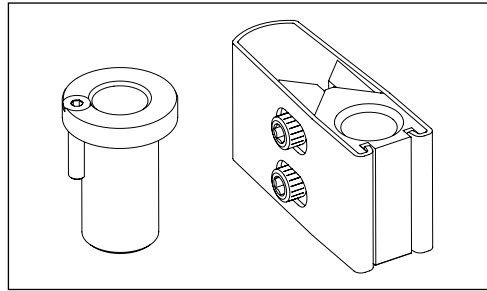

MB-UN

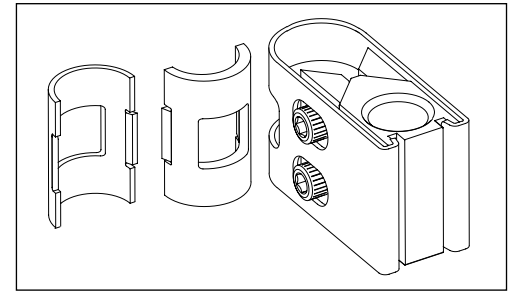

MBR-US - 1" - 7/8" - 3/4" inches (19/22/25 mm)

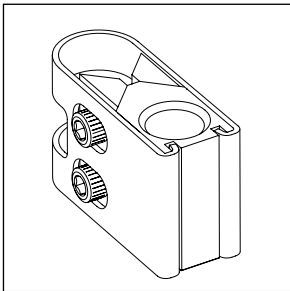

MBR - 16/20/22/25/32

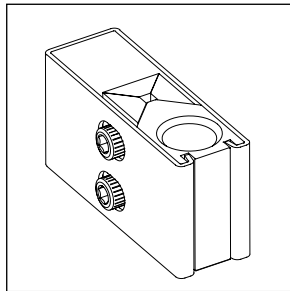

MBS-22

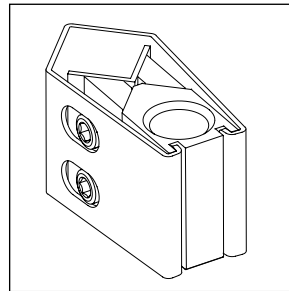

MBD-22

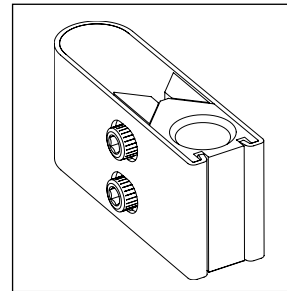

MBDD -16/20mm

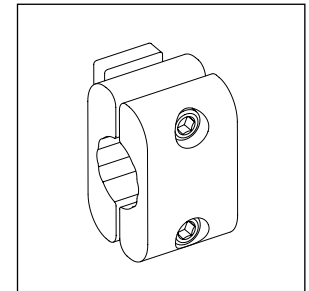

BBMB-20/22/25

## Mounting Blocks For V-trak & V-trak Lite Hardware

**MOUNTING BLOCKS For V-Trak & V-Trak Lite Hardware- SOLD AS A PAIR**

PRODUCT CODE	DESCRIPTION
<b>Universal Mounting Blocks For Round Section Canes - Diameters 19-25mm (3/4"-1")</b>	
MBR-UE	Mounting Blocks Universal - configured for Europe - 19/22/25 mm
MB-UN	Mounting Blocks, Universal - Etac/Netti
MBR-US	Mounting Blocks, Universal - configured for USA- 1" - 7/8" - 3/4" inches (19/22/25 mm)
<b>Mounting Blocks for specific diameter round section canes</b>	
MBR-16	Mounting Blocks, 16mm dia inc spacer
MBR-20	Mounting Blocks, 20mm dia
MBR-22	Mounting Blocks, 22mm dia
MBR-25	Mounting Blocks, 25mm dia
MBR-32	Mounting Blocks, 32mm dia
<b>Universal Mounting Blocks for square and "Double D" section canes</b>	
MBS-22	Mounting Blocks, 22mm square
MBD-22	Mounting Blocks, 22mm diagonal
MBDD-16	Mounting Blocks, 16mm DD inc spacer
MBDD-20	Mounting Blocks, 20mm DD

## Mounting hardware for rigidizer bars

**Brace Bar Mounting blocks - requires no additional hardware - mount backrest directly to brace bar / rigidizer bar of wheelchair**

PRODUCT CODE	DESCRIPTION
BBMB-20	Brace Bar Mounting Block for 20mm Diameter rigidizer bar
BBMB-22	Brace Bar Mounting Block for 20mm Diameter rigidizer bar
BBMB-25	Brace Bar Mounting Block for 20mm Diameter rigidizer bar



# Product list

V-TRAK

## Mounting hardware | Product specific Mounting blocks

### Mounting Blocks - Product specific

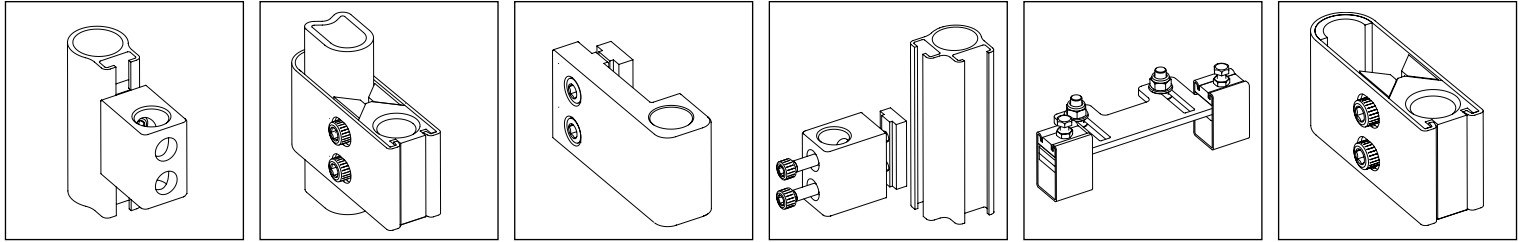

MB-82-C - R82 Cougar

MB-82-CH - R82 Cheetah

MB-HR - Hoveround

MB-RA - Rea Assist

MB-BH - Badger Chair

MB-ROX - Roxx

#### MOUNTING BLOCKS - PRODUCT SPECIFIC - SOLD AS A PAIR

##### PRODUCT CODE

MB-82-C	Mounting Block for the R82 Cougar
MB-82-CH	Mounting Block for the R82 Cheetah
MB-HR	Mounting Blocks for Hoveround Wheelchair
MB-RA	Mounting Block for the Rea Assist and Bellis
MB-BH	Badger Chair mounting kit (Sold as single)
MB-ROX	Mounting Blocks for Roxx

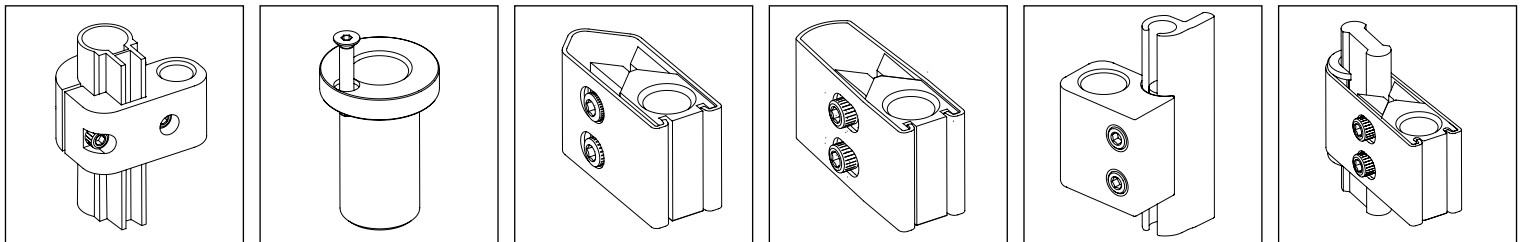

MC-ETAC - Next Comfort

MI-ETAC - Height Tube

MB-ET - ETAC

MB-NT | Netti

MB-BRIX

MB-SKS - SKS Wheelchair

#### MOUNTING BLOCKS - PRODUCT SPECIFIC - SOLD AS A PAIR

##### PRODUCT CODE

MC-ETAC	Mount Clamp for Etac Next/Next Comfort
MI-ETAC	Insert for ETAC Height Adj Tube
MB-ET	Mounting Blocks, ETAC
MB-NT	Mounting Blocks, Netti
MB-BRIX	Mounting Blocks,
MB-SKS	Mounting Blocks SKS Wheelchair

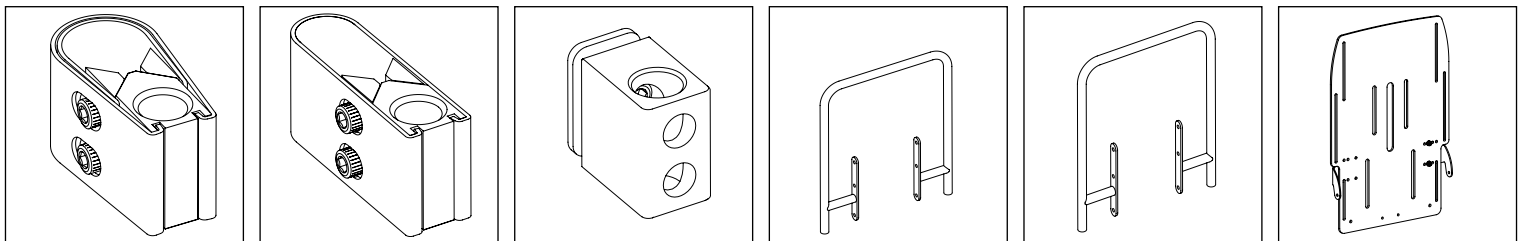

MBR-28 - Quickie

MB-RJ - DD 23mm

MB-BLD - Balder chair

BLD-FRM

BLD-FRMX

BLD-PLT

#### MOUNTING BLOCKS - PRODUCT SPECIFIC - SOLD AS A PAIR

##### PRODUCT CODE

MB28	Mounting Blocks, 28mm dia - Quickie
MB-RJ	Mounting Blocks, 23mm DD
MB-BLD	Mounting Blocks for the Balder Wheelchair

##### Balder Mounting Frames

BLD-FRM	Balder Interface Frame Assembly - requires CMA and Mounting blocks MBR 22 - order separately
BLD-FRMX	Balder Interface Frame Assembly Extended - requires CMA and mounting blocks MBR 22 - order separately
BLD-PLT	Balder Backrest Plate Extended - requires CMA and Mounting Blocks MB BLD - order separately



# Product list

V-TRAK

## Accessories | X-Tend Headrests

### X-Tend Interface Hardware only

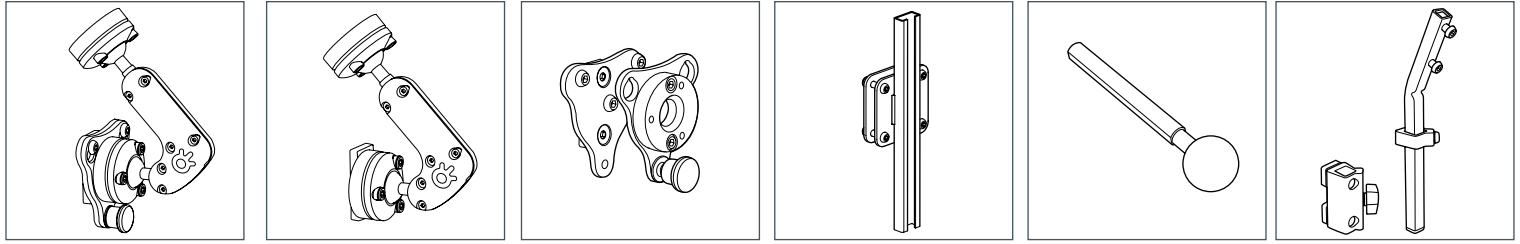

HIXQ - complete with QR

HIX - Interface only

HIQ - Quick Release only

HI MT 5- Mounting Track

HI BS - Ball stem 90/100

HI ME - Adapter stem

#### X-Tend Headrest hardware - Multi adjustable quick release hardware

PRODUCT CODE	DESCRIPTION
HIXQ	X-Tend headrest interface with QR attachment
HIX	X-Tend headrest interface without QR attachment
HIQ	X-Tend interface quick release system only
HI MT 5	Mounting track for custom backrests, Planar, foam in place/foam carve.
HI ME	Adapter stem for extended height
HI BS9	Spare standard ball stem (90mm length)
HI BS10	Optional extended ball stem (100mm length)

### Tetrixx Headrest pads only

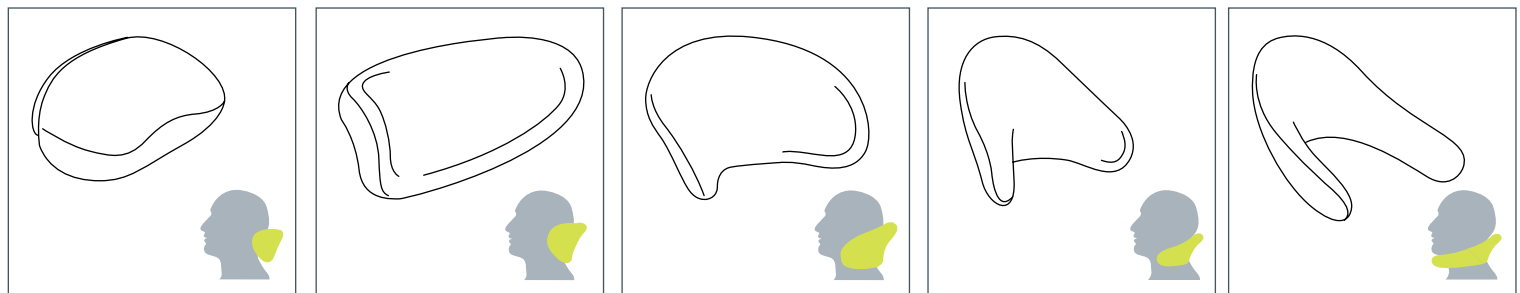

HPBB - Bead Bag

HPAW/L - Winged

HPCR - Crescent

HPCM/L - Cradle

HPCMW/LW - Cradle Winged

#### Tetrixx Headrest pads only- For use with X-Tend headrest hardware (Complete systems on page 10)

PRODUCT CODE	DESCRIPTION
<b>TETRIX - UNIVERSAL</b>	
HPBB	Universal Bead bag headrest
HPAW	Universal Adjustable winged headrest MED
HPAWL	Universal Adjustable winged headrest LARGE
<b>TETRIX - TAILORED</b>	
HPCR	Crescent shaped headrest to allow head rotation within the headrest
HPCM	Close support sub-occipital with adjustable width for precise fit- MED
HPCL	Close support sub-occipital with adjustable width for precise fit- LARGE
HPCMW	Additional extended adjustable wings for extra anterior and side support MED
HPCLW	Additional extended adjustable wings for extra anterior and side support LARGE



# Product list

V-TRAK

Accessories | Headrest Accessories & V-Trak headrests

## Headrest Accessories

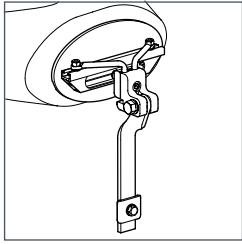

HS AC/AW/AWL - 6 way

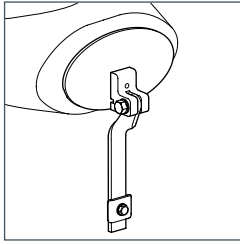

HS SC- 3 Way

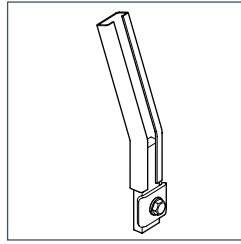

BMHX

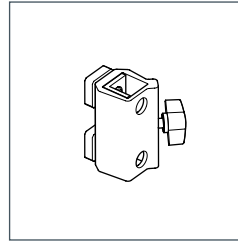

HA 14/17/20

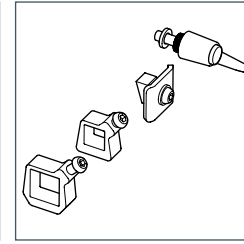

HAQRKH

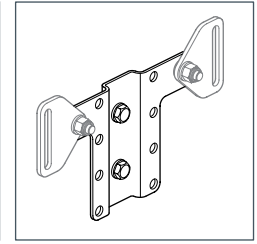

APAEG & HAPATT

### ORIGINAL V-TRAK HEADREST

PRODUCT CODE	DESCRIPTION
HSSC	3 Way Hardware & Adjustable Head Support & Bead Bag
HSAC	6 way Hardware & Adjustable Head Support & Bead Bag
HSAW	6 Way Hardware & Adjustable Winged Head Support
HSAWL	6 Way Hardware & Adjustable Large Winged Head Support
HSBB	Replacement Bead Bag for HS SC & HS AC

### ORIGINAL V-TRAK SYSTEM HEADREST ACCESSORIES

PRODUCT CODE	DESCRIPTION
HRIXL	Headrest stem extension (10cm), for use with HS AC/AW/AWL or HSSC
BMHX	Track Extension
HAQRK	Headrest Quick Release Kit with depth stop
HA14	Headrest Adaptor for 14mm square tube
HA17	Headrest Adaptor for 17mm square tube
HA20	Headrest Adaptor for 20mm sq (Whitmeyer)
HAS10	Headrest Adaptor Spacer
HAPAEG	Headrest Adaptor Plate - T shaped adaptor plate to attach to track for mounting 3rd party headrests
HAPATT	Harness Attachment Kit - 2x Harness mounts for use with HAPAEG

## Complete X-Tend Headrest systems

### Complete systems

PRODUCT CODE	DESCRIPTION
UNIVERSAL	
H BBX	Bead bag + X-Tend interface
H BBQ	Bead Bag + X-Tend interface with Quick Release
H AWX	Winged headrest + X-Tend interface
H AWQ	Winged headrest + X-Tend interface with Quick Release
H AWLX	Large Winged Headrest + X-Tend interface
H AWLQ	Large Winged Headrest + X-Tend interface with Quick Release
TETRIXX - TAILORED	
H CRX	Universal Crescent + X-Tend interface
H CRQ	Universal Crescent + X-Tend interface with Quick Release
H CMX	Cradle Headrest MED + X-Tend interface
H CMQ	Cradle Headrest MED + X-Tend interface with Quick Release
H CLX	Cradle Headrest LARGE & X-Tend interface
H CLQ	Cradle Headrest LARGE & X-Tend interface with Quick Release
H CMWX	Cradle Winged Headrest MED + X-Tend interface
H CMWQ	Cradle Winged Headrest MED + X-Tend interface with Quick Release
H CLWX	Cradle Winged Headrest LARGE & X-Tend interface
H CLWQ	Cradle Winged Headrest LARGE & X-Tend interface with Quick Release





# Product list

V-TRAK

Accessories | Laterals

## Laterals

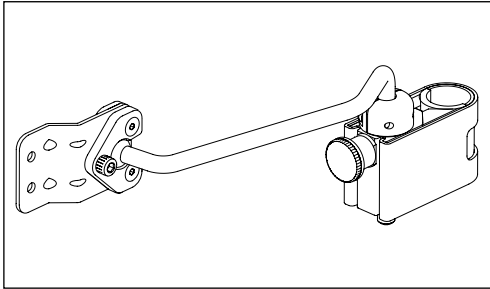

TSCM LH / RH - Cane mounted No pad

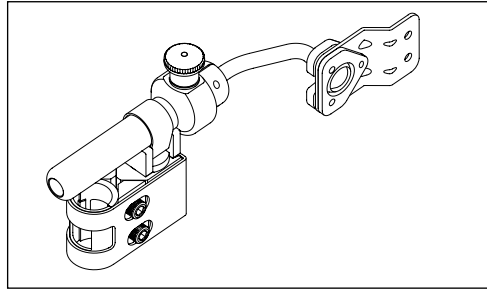

TSACM U - Cane mounted No pad

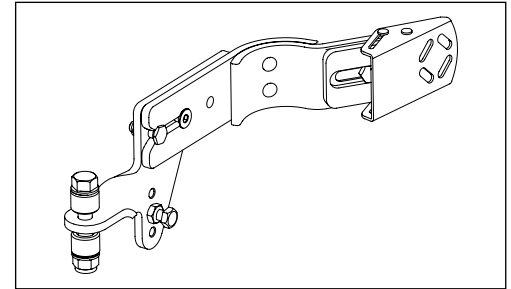

TS2 LH/LR - For V-Trak Original hardware

## New Cane mounted Thoracic (Lateral) supports

### PLEASE NOTE :

Cane mounted Thoracic Supports are equipped with a Universal Clamp Band to suit round section canes with diameters from 19mm (3/4") to 25mm (1"). For other cane configurations please identify the mounting block normally required for the cane in use and order separately.

### CANE MOUNTED LATERAL SUPPORTS (HARDWARE) - Multi adjustable ball head pad and quick release / swing away as standard - 19mm-25mm

PRODUCT CODE	DESCRIPTION
--------------	-------------

TSCM LH	Cane mounted Lateral Thoracic Support - Quick release and swing away hardware - Left hand
---------	---

TSCM RH	Cane mounted Lateral Thoracic Support - Quick release and swing away hardware - Right hand
---------	--

### CANE MOUNTED SINGLE ANTERIOR THORACIC SUPPORT - can be used on left or right side

PRODUCT CODE	DESCRIPTION
--------------	-------------

TSACM U	Cane mounted Single Anterior Thoracic Support - can be used on left or right side
---------	---

### PADS for all Anterior / Thoracic Support cane mounted and V-Trak original

PRODUCT CODE	DESCRIPTION	HEIGHT	WIDTH cm
--------------	-------------	--------	----------

TSCM LP	Large Thoracic Lateral/Anterior Support Pad - can be used on left or right side		
---------	---	--	--

TSCM MP	Medium Thoracic Lateral/Anterior Support Pad - can be used on left or right side		
---------	--	--	--

## Thoracic (Lateral) Supports to fit V-Trak Original

### V-Trak original Thoracic supports - Attach directly on to V-Trak original Hardware

PRODUCT CODE	DESCRIPTION
--------------	-------------

TS2LH	Thoracic Support hardware, Left Hand (no pad)
-------	---

TS2RH	Thoracic Support hardware, Right Hand (no pad)
-------	--

TS2LPL	Large Thoracic Pad & Cover - Left
--------	-----------------------------------

TS2LPR	Large Thoracic Pad & Cover - Right
--------	------------------------------------

TS2MPL	Medium Thoracic Pad & Cover - Left
--------	------------------------------------

TS2MPR	Medium Thoracic Pad & Cover - Right
--------	-------------------------------------

TS2AA	Extended Thoracic Attachment Arm (Special) 50mm additional length
-------	---

TS2CP L	Thoracic Clamping Plate only
---------	------------------------------

TS2CP R	Thoracic Clamping Plate only
---------	------------------------------

TS2LHCR	Thoracic Support Left Hand - lever release (no pad)
---------	---

TS2RHCR	Thoracic Support Right Hand lever - release (no pad)
---------	--

R82UAP	Universal Adaptor Plate, for fitting R82 Lateral Supports
--------	---

TSOBL	Right Hand Clamp Plate to fit Otto Bock STS system
-------	--

TSOB	Left Hand Clamp Plate to fit Otto Bock STS system
------	---



# Product list

V-TRAK

Accessories | Harness carriers & Secondary arms

## Harness carriers

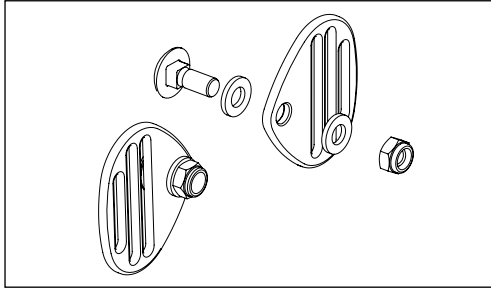

BMAHK

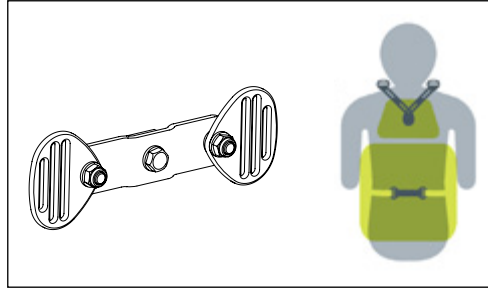

BMAHC

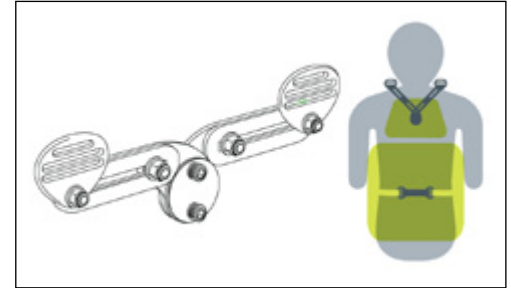

UHC

### Attachment devices for straps and harnesses

PRODUCT CODE	DESCRIPTION
BMAHC	Harness Carrier (four point)
BMAHK	Harness Attachment Kit for use with secondary arms
UHC	NEW Universal, extendable Harness Carrier

## Secondary arm

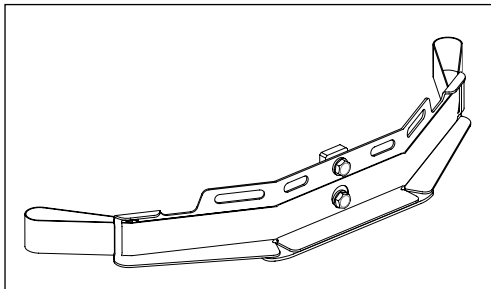

BMSAS

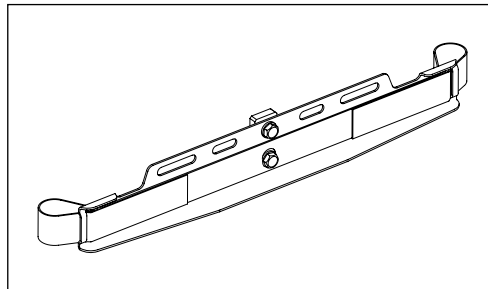

BMSSS

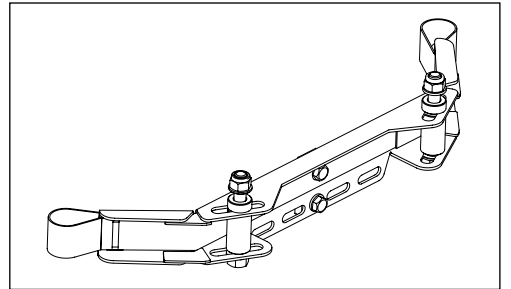

BMSAT

### SECONDARY ARMS FOR ADDITIONAL SUPPORT & MOUNTING

PRODUCT CODE	DESCRIPTION
BMSAS15	Secondary Arm System, 15"(38cm)
BMSAS17	Secondary Arm System, 17"(43cm)

### Flat Secondary Arms

BMSSS15	Flat Secondary Arm System, 15"(38cm)
BMSSS17	Flat Secondary Arm System, 17"(43cm)

### Cranked Secondary Arms for lateral support mounting

BMSAT13	Paediatric Secondary Arm System (chairs < 15" wide)
BMSAT15	Secondary Arm with Thoracic Support Mount 15"
BMSAT17	Secondary Arm with Thoracic Support Mount 17"



# Product list

V-TRAK

Accessories | V-Trak Accessories

## V-Trak general Accessories

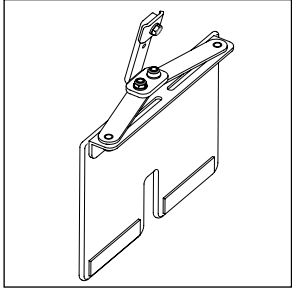

BMACR

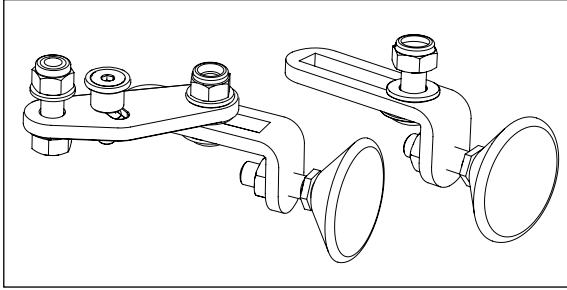

BMSTX / BMSTA

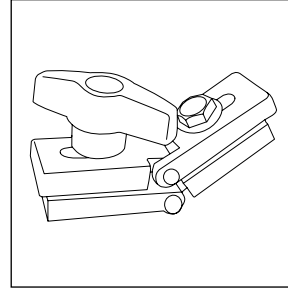

SH HD

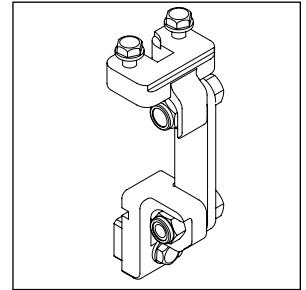

VTOPL

### CUSHION LOCATION AND RETENTION AID

PRODUCT CODE	DESCRIPTION
BMACR	Cushion location and retention aid that attaches to track and attaches to cushion with Velcro

### Shell Stabilizers to prevent/regulate shell flexing.

PRODUCT CODE	DESCRIPTION
BMSTA	Shell stabiliser (pair)
BMSTX	Extended shell stabiliser (pair)

## Hinge

### HARDWARE AND CONNECTING HINGE (SH SD)

PRODUCT CODE	DESCRIPTION
SH SD	Track and hardware connecting hinge

## Pivot Lock

### V-TRAK ORIGINAL PIVOT LOCK

PRODUCT CODE	DESCRIPTION
VTOPL	V-Trak Original Pivot Lock - Pivot point locking mechanism for extra resistance to rotation



# Product list

V-TRAK

Specialist seating | Hardware & Tracks

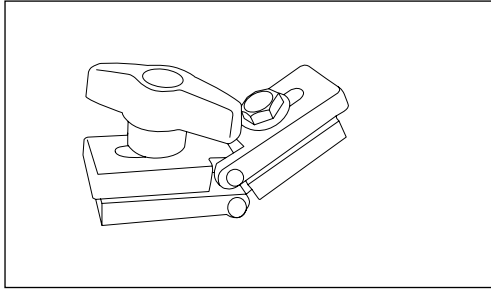

SHSD

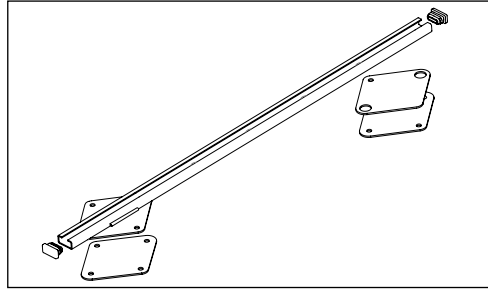

VTSS

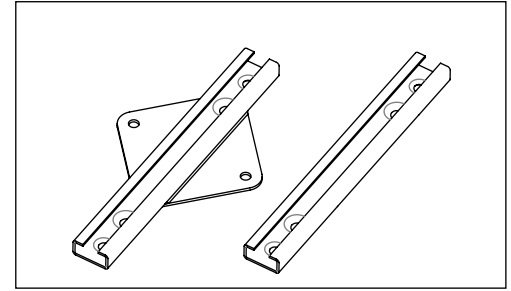

TP / T - Tracks

Special Seating Tracks can be used with track hinge SH SD to make sectional backrests Plain tracks, plated and punched for fixing screws

PRODUCT CODE	DESCRIPTION	TRACK LENGTH (mm)
T 130	Plain tracks, plated and punched for fixing screws	130mm
T 140	Plain tracks, plated and punched for fixing screws	140mm
T 192	Plain tracks, plated and punched for fixing screws	192mm
T 282	Plain tracks, plated and punched for fixing screws	282mm
T 375	Plain tracks, plated and punched for fixing screws	375mm
T 930	Plain tracks, plated and punched for fixing screws	930mm

Special Seating Tracks with diamond plates, plated, punched for fixing screws (screws not supplied)

PRODUCT CODE	DESCRIPTION	TRACK LENGTH (mm)
TP 192	Tracks with diamond plates, plated, punched for fixing screws	192mm
TP 282	Tracks with diamond plates, plated, punched for fixing screws	282mm
TP 375	Tracks with diamond plates, plated, punched for fixing screws	375mm
TP 655	Tracks with diamond plates, plated, punched for fixing screws	655mm

Special Seating Track kits - with diamond plates, plated, punched for fixing screws

PRODUCT CODE	DESCRIPTION	TRACK LENGTH (mm)
VTS	Sports Track Kit (inc screws & caps) (375mm)	375mm
VTL	Standard Track Kit (inc screws & caps) (417mm)	417mm
VTSS	Special Seating Mounting Kit (655mm)	655mm
VTSSR	Long Track Kit (930mm)	203mm
VTH	Special Seating Mounting Kit (655mm)	930mm

## Central mounts only

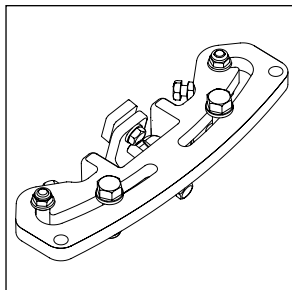

CMU

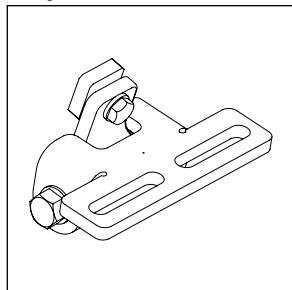

CMS STD2

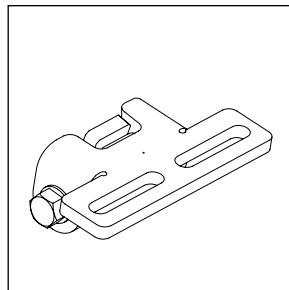

CMSTD

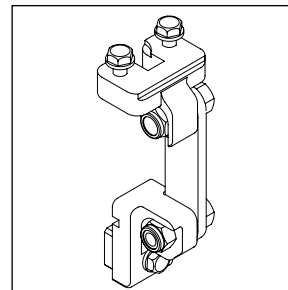

VTOPL

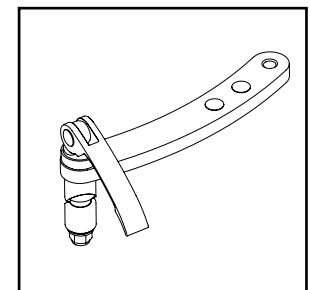

ARMS ORDERED SEPARATELY

Central Mounts only Use to join Arms of equal or different sizes and/or handing (left and right)

PRODUCT CODE	DESCRIPTION
CMU	Improved Universal Central Mount - Aluminium (recommended) with built in rotation lock
CM STD 2	Steel Central Mount (specialist application only)
BM ALP	Locking plate for Steel Central Mount
CM STD	Steel Central mount, single hole fixing (for short segment tracks) recommended for paediatrics
VTOPL	V-Trak Original Pivot Lock - Pivot point locking mechanism for extra resistance to rotation



# Product list

V-TRAK

Specialist seating | Parts, Recycling kits & Fabric

## Parts - Pack of multiples

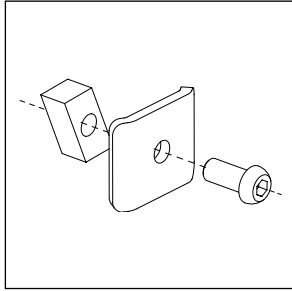

TDS - Track Depth Stop

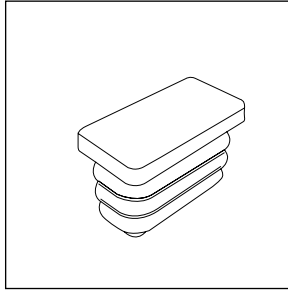

ECTR - Track End Cap

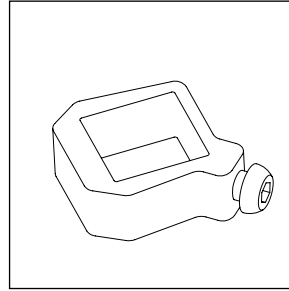

HDS -Headrest depth stop

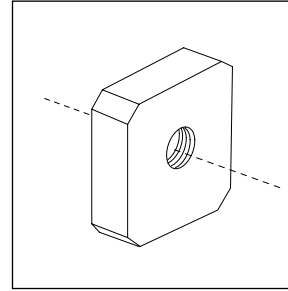

V15A - Track slider

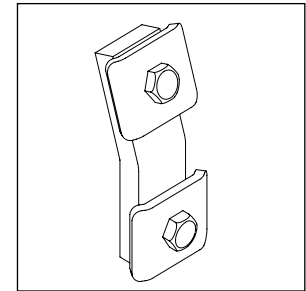

TJB- Track Joiner Bent

### Parts used with V-trak Hardware and tracks available in packs

PRODUCT CODE	DESCRIPTION
TDS 10	TRACK DEPTH STOP - packs of 10 - Used for setting headrest and hardware height in V-trak track
HDS 10	HEADREST DEPTH STOP - packs of 10 - Used for setting headrest and hardware height- 14/17/20mm
V15A	TRACK SLIDER - packs of 10 - Used for setting headrest and hardware height in V-trak track
ECTR	TRACK END CAP - packs of 25 - Used to finish and protect the end of V-Trak tracks
M625WK	WING KNOBS -packs of 25- M6 x 25 used for hinges and track sliders etc
TJB	TRACK JOINER - Bent track joiner for use with V-Trak track (TP/T)

## Hardware recycling kits for refurbishment of V-Trak Hardware

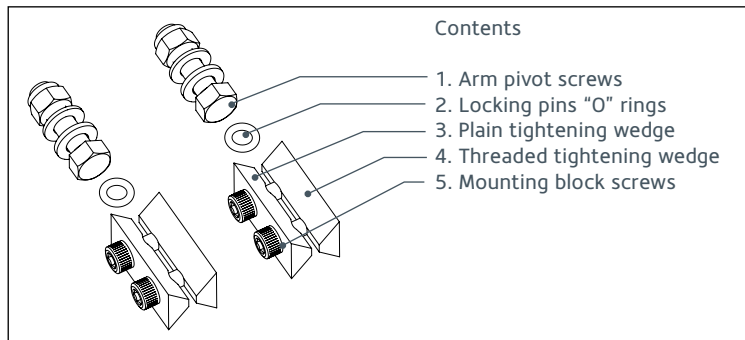

BM ARK - For Mounting Blocks & V-Trak arms

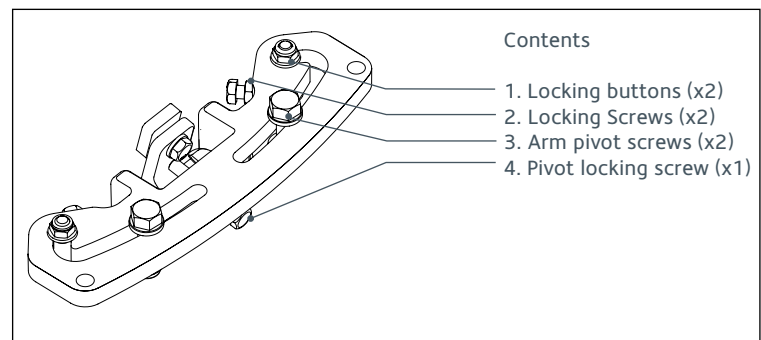

CMA SV - For Universal Central mount (CMU)

### HARDWARE RECYCLING KITS -

PRODUCT CODE	DESCRIPTION
CMA SV	For Universal Central mount (CMU)
BM ARK	For Mounting blocks (MBR) & V-Trak arms

## Fabric

### Fabric used on Axxis , Axxis Profile Comfort and Evo backrests Available in linear meters

PRODUCT CODE	DESCRIPTION
BB	<b>Woven fabric</b> - MFC with water-resistant backing- (Axxis segmented and Axxis one piece as standard)
WF	<b>Breathable Black</b> - Spacer Fabric - (Axxis Profile range as standard)
WD	<b>Dual Tone</b> - Grey spacer fabric with contrasting MFC woven fabric - (Comfort range and Evo+ as standard)
DT	<b>Wipe down</b> - Water resistant polyurethane material

### PLEASE NOTE :

All fabrics are fire retardant



# Product list

V-TRAK

NOTES :

